

UNIPLAST[®]

Innovations for Better Tomorrow.

Over **3** decades of Trust



Mi smo Uniplast, porodično preduzeće sa više od tri decenije iskustva. Ponosni smo što predvodimo regionalno tržište u proizvodnji i distribuciji farmaceutske, medicinske i kozmetičke ambalaže.

Tokom godina, posvetili smo se unapređenju proizvoda, proširenju asortimana i jačanju partnerskih odnosa sa klijentima. U tom periodu, razvili smo preko 200 različitih proizvoda, koji su uspešno isporučeni u više od 16 zemalja širom sveta, uz tendenciju da konstantno širimo svoju prisutnost u svetu.

We are Uniplast, a family-owned business with over three decades of experience. We are proud to be at the forefront of the regional market in the production and distribution of pharmaceutical, medical, and cosmetic packaging.

Over the years, we have dedicated ourselves to product improvement, expanding our range, and strengthening partnerships with our clients. During this time, we have developed over 200 different products, which have been successfully delivered to more than 16 countries worldwide, with a continual drive to expand our global presence.

Zemlje izvoza Export Countries

Bosnia & Herzegovina
Albania
Croatia
Montenegro
Georgia
North Macedonia
Slovenia
Romania
Czech Republic
Germany
Belgium
Moldova
UAE
Bulgaria
France
Greece



Sertifikati Certificates



Posebnu pažnju poklanjamo kvalitetu svake serije proizvoda, a naše poslovanje odvija se u skladu sa sledećim ISO standardima: ISO 9001, ISO 14001, ISO 45001, ISO 15378 (GMP), i ISO 13485:2016 (IVD sterilna i nesterilna).

We pay special attention to the quality of each production batch, and our operations are conducted in accordance with the following ISO standards: ISO 9001, ISO 14001, ISO 45001, ISO 15378 (GMP), and ISO 13485:2016 (IVD sterile and non-sterile).

Aktivna ambalaža je napravljena kombinacijom plastičnih materijala koje već uspešno proizvodimo sa zeolitom koji sadrži jone srebra. Zeolit će oslobađati srebro unutar pakovanja. Joni srebra su snažan antimikrobni agens i u veoma malim koncentracijama uništavaju većinu patogenih mikroorganizama.

Glavni ciljevi aktivne ambalaže su da uništi patogene ili zaustavi reprodukciju mikroorganizama, čime se proizvod čini sigurnijim za potrošače, povećava rok trajanja bez konzervansa, što je bolje za potrošače.

Active packaging is made by combining plastic and zeolite. Silver ions are very strong antimicrobial agents and at very small concentrations they will destroy the most of pathogenic microorganisms.

Main goals of Active packaging is to destroy pathogenic and stop reproduction of microorganisms, making product safer for consumer, increasing shelf life without conservans, which is better for consumer.

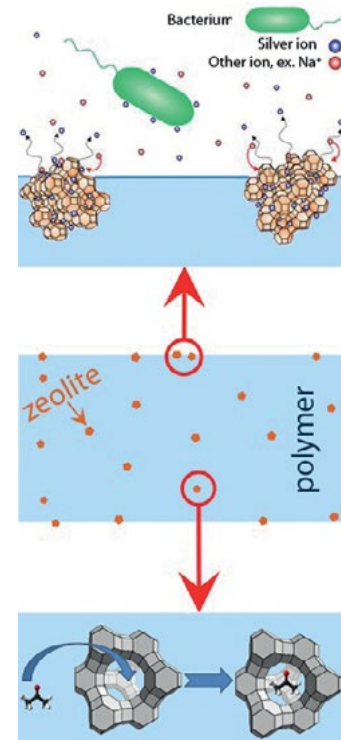

Eco Friendly ambalaža je napravljena od 60% drvenih vlakana i 40% plastike.

Glavni ciljevi Eco Friendly ambalaže su:

- Proširivanje ponude prirodnim proizvodom u ekološkoj ambalaži.
- Pružanje ekološki odgovornog pristupa poboljšanju proizvoda.
- Smanjenje plastičnog otpada na Zemlji.

The Eco Friendly packaging is made from 60% wood fibers and 40% plastic.

The main goals for Eco Friendly packaging are:

- Expanding the product range with a natural product in eco-friendly packaging.
- Providing an environmentally responsible approach to product improvement
- Reducing plastic waste on Earth





UNIPLAST[®]
Innovations for Better Tomorrow.



BOCE

BOTTLES



AQUA

Plastične boce | sa tamper proof zatvaračem
Bottles with Tamper Proof Cap

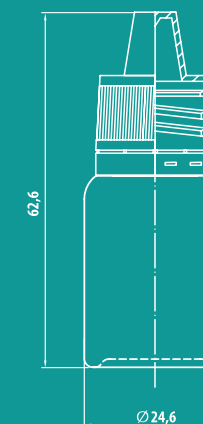
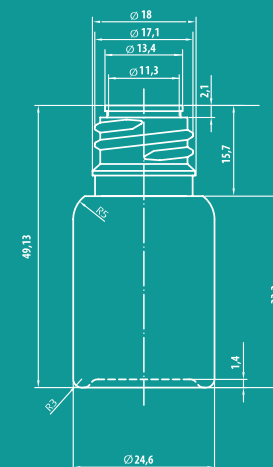
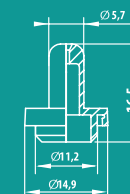
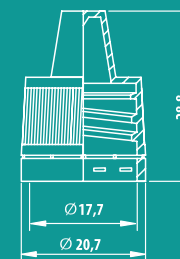

Za pakovanje tečnih farmaceutskih proizvoda. Poklopci sa sigurnosnim prstenom obezbeđuju originalnost pakovanja i evidenciju prvog otvaranja. Kapaljka integrisana u poklopcu donosi brojne benefite, kao što je zaštita proizvoda od mogućnosti kontaminacije prilikom pakovanja i ušteda vremena pakovanja u procesu proizvodnje.

For packaging liquid pharmaceutical products. Caps with a security ring ensure record of the first opening. The dropper integrated into the cap offers numerous benefits, such as protecting the product from potential contamination during packaging and saving time in the packaging process during production.



22010

ml	H	R	material
10	62.6	24.6	LDPE-HDPE



22020

ml	H	R	material
20	72.7	28.5	LDPE-HDPE



22100

ml	H	R	material
100	125	41.4	LDPE-HDPE



22200

ml	H	R	material
200	143	52.5	LDPE-HDPE



22030

ml	H	R	material
30	80.9	31	LDPE-HDPE



22050

ml	H	R	material
50	98.6	36.5	LDPE-HDPE



22300

ml	H	R	material
300	194	52.5	LDPE-HDPE



22400

ml	H	R	material
400	185	61.5	LDPE-HDPE

AQUA

Plastične boce | sa tamper proof zatvaračem
Bottles with Tamper Proof Cap



22500

ml	H	R	material
500	198	68.3	LDPE-HDPE



221000

ml	H	R	material
1000	250	83	LDPE-HDPE



181000

ml	H	R	material
1000	241	86.8	HDPE



261000

ml	H	R	material
1000	252	78.3/61.3	LDPE-HDPE



271000

ml	H	R	material
1000	267	78.3/62.6	LDPE-HDPE



18500

ml	H	R	material
500	192	72	HDPE

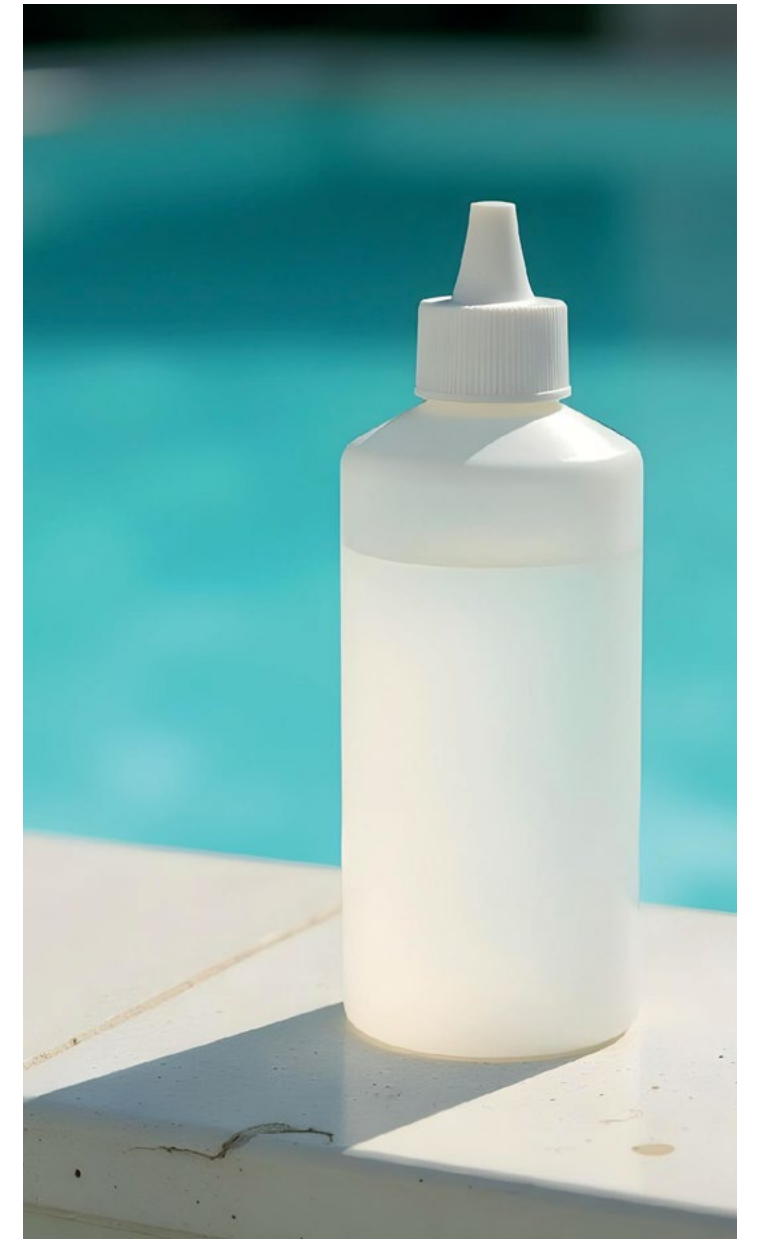



31020

ml	H	R	material	∅
20	90.7	26.5	HDPE	18/410 mm



31030

ml	H	R	material	∅
30	107	28	HDPE	18/410 mm



31201

ml	H	R	material	∅
200	152	52.5	HDPE	20/410 mm



31300

ml	H	R	material	∅
300	203	52.5	HDPE	20/410 mm



31050

ml	H	R	material	∅
50	107.1	36.5	HDPE	18/410 mm



31100

ml	H	R	material	∅
100	133	41.4	HDPE	20/410 mm



31400

ml	H	R	material	∅
400	195	61.5	HDPE	20/410 mm



31500

ml	H	R	material	∅
500	204	68.3	HDPE	20/410 mm

26100

ml	H	R	material	∅
100	140.7	49.8/32.9	HDPE	20/410 mm



36100

ml	H	R	material	∅
120	173	42.4	HDPE	24/410 mm



36200

ml	H	R	material	∅
200	228	45	HDPE	24/410 mm



32010

ml	H	R	material	∅
10	93	24.6	HDPE	18/410 mm



32020

ml	H	R	material	∅
20	110	26.5	HDPE	18/410 mm



36400

ml	H	R	material	∅
400	220	62	HDPE	24/410 mm



36500

ml	H	R	material	∅
500	234	68.5	HDPE	24/410 mm



32030

ml	H	R	material	∅
30	121/128	28	HDPE	18/410 mm



33020

ml	H	R	material	∅
20	85.2	26.5	HDPE	18/410 mm



33030

ml	H	R	material	∅
30	101/104.4	28	HDPE	18/410 mm



SANA

Plastične boce | sa klik klak zatvaračem
Plastic Bottles with Flip Top Cap

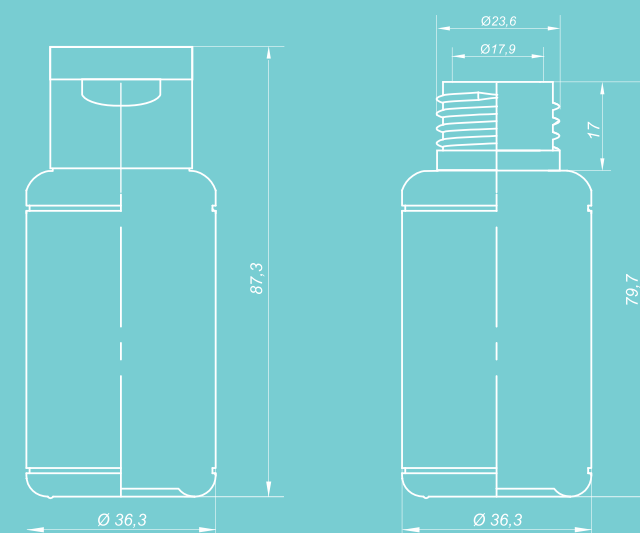
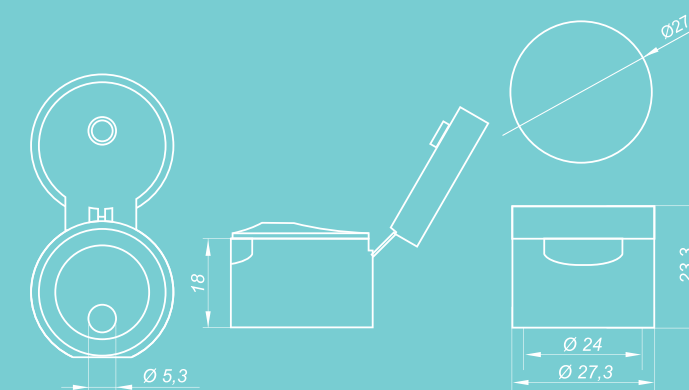

Koriste se za pakovanje polučvrstih i tečnih kozmetičkih preparata, kao što su tonici, kozmetička mleka, serumi i slični proizvodi. „Klik-klak“ mehanizam omogućava jednostavno otvaranje i zatvaranje.

They are used for packaging semi-solid and liquid cosmetic products, such as toners, cosmetic milks, serums, and similar products. The flip flop mechanism allows easy opening and closing.



52051

ml	H	R	material	∅
50	86.3	36.5	HDPE	20/410 mm



52052

ml	H	R	material	∅
50	87.3	36.3	HDPE	24/410 mm



52201

ml	H	R	material	∅
200	130	52.5	HDPE	20/410 mm



52202

ml	H	R	material	∅
200	180	45	HDPE	24/410 mm



52101

ml	H	R	material	∅
100	113.7	41.4	HDPE	20/410 mm



52102

ml	H	R	material	∅
120	127.2	42.4	HDPE	24/410 mm



52301

ml	H	R	material	∅
300	184	52.5	HDPE	20/410 mm



52401

ml	H	R	material	∅
400	175	61.5	HDPE	20/410 mm



52402

ml	H	R	material	∅
400	175	62	HDPE	24/410 mm



52502

ml	H	R	material	∅
500	187	68.5	HDPE	24/410 mm



52501

ml	H	R	material	∅
500	189	68.3	HDPE	20/410 mm

521001

ml	H	R	material	∅
1000	238	83	HDPE	20/410 mm



51200

ml	H	R	material
200	152	62.9	HDPE



OLEA

Plastične boce | sa običnim zatvaračem
Plastic Bottles with regular cap

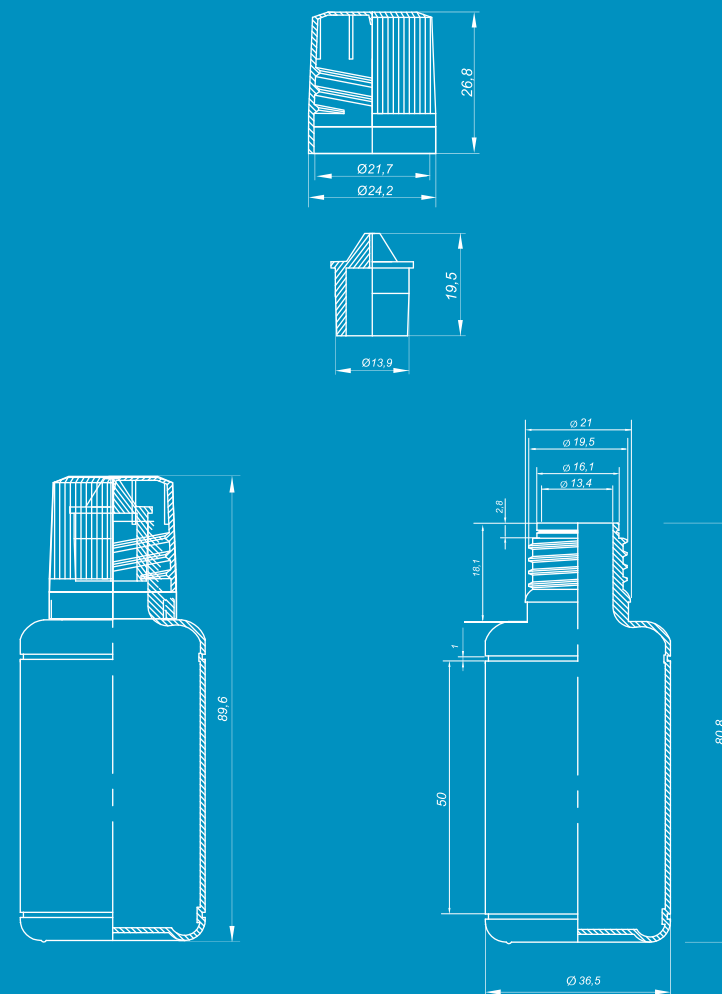

Ove boce namenjene su za čuvanje farmaceutskih proizvoda kao što su farmaceutske supstance, magistralni, galenski i gotovi tečni lekovi.

For storing pharmaceutical products such as pharmaceutical substances, compounded, galenic, and ready-to-use liquid medications.



20050

ml	H	R	material
50	89.6	36.5	HDPE



20100

ml	H	R	material
100	116.1	41.4	HDPE



20300

ml	H	R	material
300	186	52.5	HDPE



20400

ml	H	R	material
400	176	61.5	HDPE



18150

ml	H	R	material
150	131	50	HDPE



20200

ml	H	R	material
200	133.2	52.5	HDPE



20500

ml	H	R	material
500	190	68.3	HDPE



201000

ml	H	R	material
1000	238	83	HDPE

AURA

Plastične boce | Airless
Plastic Bottles Airless

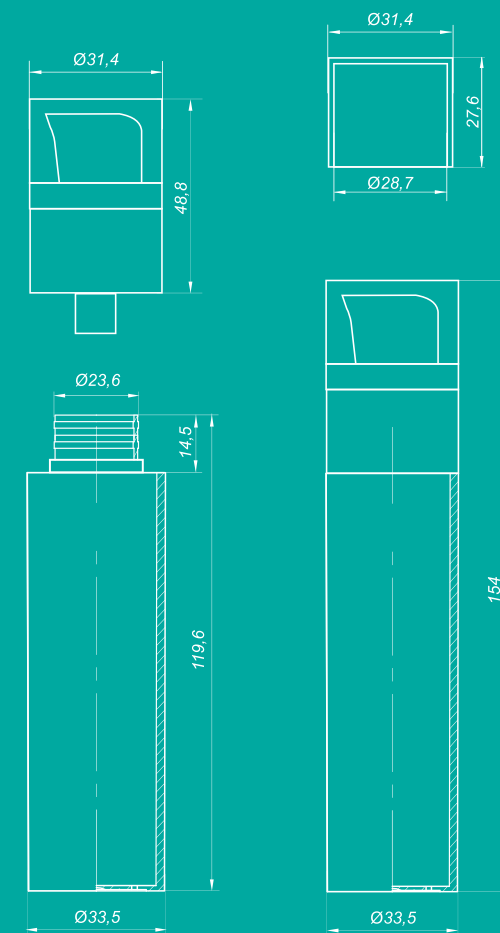

Airless boce su dizajnirane za pakovanje polučvrstih kozmetičkih preparata. Njihova prednost leži u tome što su potpuno plastične, bez metalnih delova. Imaju automatski samozaptivni ventil koji sprečava kontakt sa vazduhom, čime se smanjuje rizik od kontaminacije i oksidacije preparata. Omogućavaju doziranje u bilo kojem položaju, a procenat iskorišćenosti preparata prelazi 98%.

Airless bottles are designed for packaging semi-solid cosmetic products. Their advantage lies in being entirely plastic, with no metal parts. They feature an automatic self-sealing valve that prevents contact with air, reducing the risk of contamination and oxidation of the product. They allow dosing from any position, and the utilization rate of the product exceeds 98%.

AURA

Plastične boce | Airless
Plastic Bottles Airless



40030

ml	H	R	material
30	122.3	33.5	PP-PE



40050

ml	H	R	material
50	154	33.5	PP-PE



FLORA

Plastične boce | Kozmetičke
Cosmetic Plastic Bottles

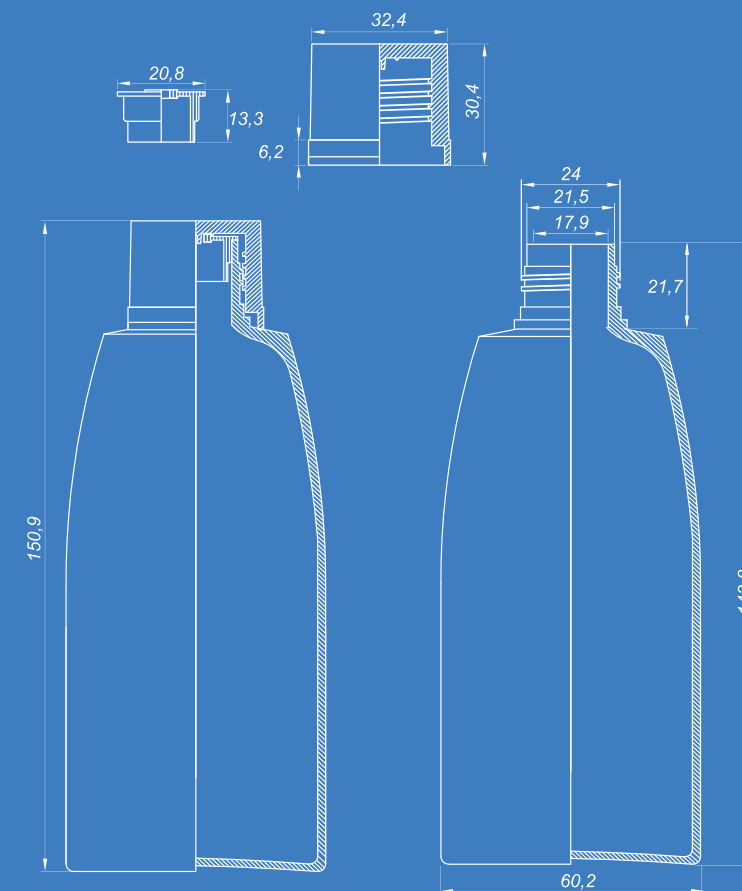

Koriste se za sigurno skladištenje i aplikaciju različitih kozmetičkih preparata, uključujući kreme, tonike i šampone. Ove boce dolaze u različitim oblicima i veličinama, često sa specijalnim zatvaračima poput pumpica i dozatora.

They are used for the safe storage and application of various cosmetic products, including creams, toners, and shampoos. These bottles come in different shapes and sizes, often with special closures such as pumps and dispensers.

FLORA

Plastične boce | Kozmetičke
Cosmetic Plastic Bottles



50150

ml	H	R	material
150	150.9	60.2	HDPE

● Gold ● Silver



50200

ml	H	R	material
200	176	65.1	HDPE

● Gold ● Silver



34050

ml	H	R	material
50	108	36.3	HDPE



34100

ml	H	R	material
120	148	42.4	HDPE



34500

ml	H	R	material
500	215	68.5	HDPE



34102

ml	H	R	material
120	144	42.4	HDPE



34200

ml	H	R	material
200	202	45	HDPE



34400

ml	H	R	material
400	197	62	HDPE



34202

ml	H	R	material
200	197	45	HDPE



34402

ml	H	R	material
400	192	62	HDPE

FLORA

Plastične boce | Kozmetičke
Cosmetic Plastic Bottles



34502

ml	H	R	material
500	205	68.5	HDPE



27300

ml	H	R	material
300	205	52.5	HDPE



27100

ml	H	R	material
100	140	49.8	HDPE

27050

ml	H	R	material
50	107	36.5	HDPE



27200

ml	H	R	material
200	152	52.5	HDPE



LUNA



Staklene boce Glass Bottles

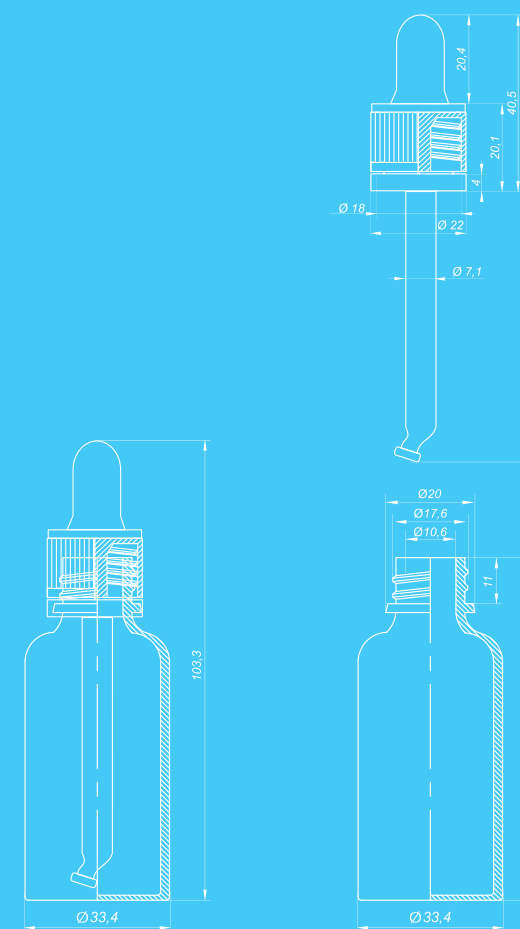

Proizvedene od obojenog natron silika stakla III hidrolitičke grupe sa umerenim hidrolitičkim otporom. Kompatibilne sa „tamper-proof“ poklopcima sa sigurnosnim prstenom koji osiguravaju originalnost pakovanja i evidenciju prvog otvaranja.

Made from Type III hydrolytic glass, colored soda-lime glass with moderate hydrolytic resistance. Compatible with tamper-proof caps with a security ring that ensure the originality of the packaging and record of the first opening.



80010

ml	H	R	material
10	62.5	25	GLASS



80020

ml	H	R	material
20	80	28.9	GLASS



80030

ml	H	R	material
30	84.8	33.4	GLASS



80050

ml	H	R	material
50	96.8	37.3	GLASS



80100

ml	H	R	material
100	114.4	44.6	GLASS



80101

ml	H	R	material
100	110.5	46	GLASS





80125

ml	H	R	material
125	119.3	48.7	GLASS



80200

ml	H	R	material
200	139	56.7	GLASS



801000

ml	H	R	material
1000	222	97.6	GLASS



80010P

ml	H	R	material
10	82.4	25.2	GLASS



80250

ml	H	R	material
250	148	61.4	GLASS



80500

ml	H	R	material
500	184	76.5	GLASS



80030P

ml	H	R	material
30	103.3	33.4	GLASS



80010C

ml	H	R	material
10	61.4	25	GLASS



80020C

ml	H	R	material
20	67	28.5	GLASS



80030C

ml	H	R	material
30	83.4	33.4	GLASS



271009

ml	H	R	material
50	134.5	34	GLASS



80100S

ml	H	R	material
100	140.5	44.5	GLASS



90030

ml	H	R	material
30	117.2	30.2	GLASS

 Gold  Silver



KUTIJE

JARS



IRIS

Plastične kutije
Plastic Jars

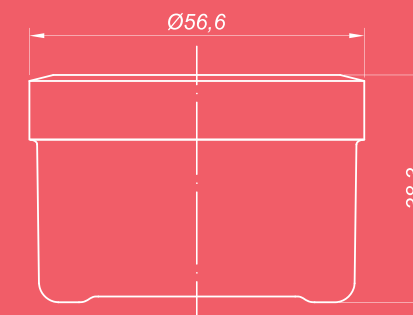
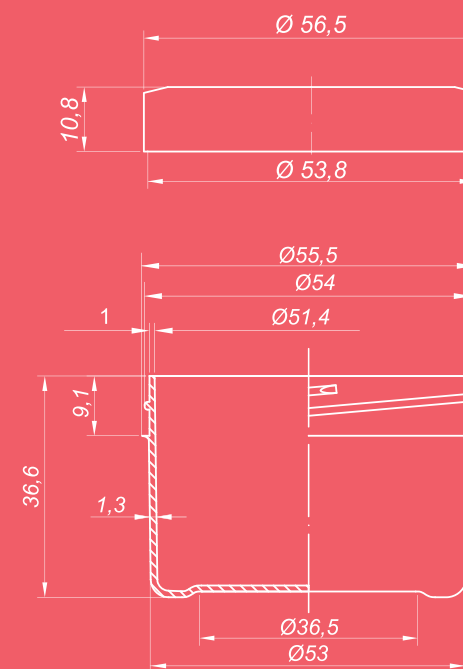

Namenjene su za pakovanje polučvrstih farmaceutskih proizvoda kao i kozmetičkih proizvoda: kreme za lice, telo, pilinzi, losioni, maske i slično.

Ideal for packaging semi-solid pharmaceutical products as well as cosmetic products: face creams, body creams, scrubs, lotions, masks, and similar items.



10015

ml	H	R	material
15	22	38	PP



10025

ml	H	R	material
25	35	38	PP



10030

ml	H	R	material
30	22.2	53.8	PP



10060

ml	H	R	material
60	38.3	56.5	PP



10100

ml	H	R	material
100	39.5	72.4	PP



10126

ml	H	R	material
125	74	56.5	PP



10250

ml	H	R	material
250	51.5	92	PP



10125

ml	H	R	material
125	45.2	72.4	PP



10185

ml	H	R	material
185	59.5	72.4	PP



10500

ml	H	R	material
500	104.4	92	PP

DAHLIA

Plastične kutije | Transparentne
Transparent Plastic Jars

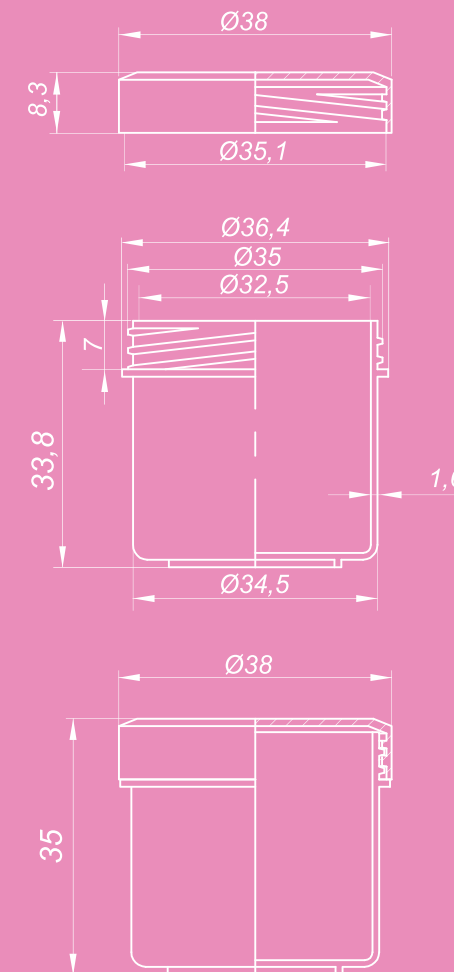

Transparentne plastične kutije za čuvanje polučvrstih i čvrstih kozmetičkih i prehrambenih proizvoda. Mogu da budu u direktnom kontaktu sa proizvodom, ako proizvod nema visok napon para. Svaki plastični kontejner može imati međupoklopac.

Transparent Plastic Boxes for storing semi-solid and solid cosmetic and food products. They can be in direct contact with the product, if the product does not have a high vapor pressure. Each plastic container can have an undercap.



11015

ml	H	R	material
15	21.9	38	PP



11025

ml	H	R	material
25	35	38	PP



11100

ml	H	R	material
100	41.8	72.6	PS-PP



11185

ml	H	R	material
185	61.5	72.6	PS-PP



11030

ml	H	R	material
30	22.2	56.5	PP



11060

ml	H	R	material
60	38.8	56.5	PS-PP



11250

ml	H	R	material
250	51	93.3	PS-PP



11375

ml	H	R	material
375	69.4	92	PS-PP

SILVA

Plastične kutije | Kozmetičke
Cosmetic Plastic Jars

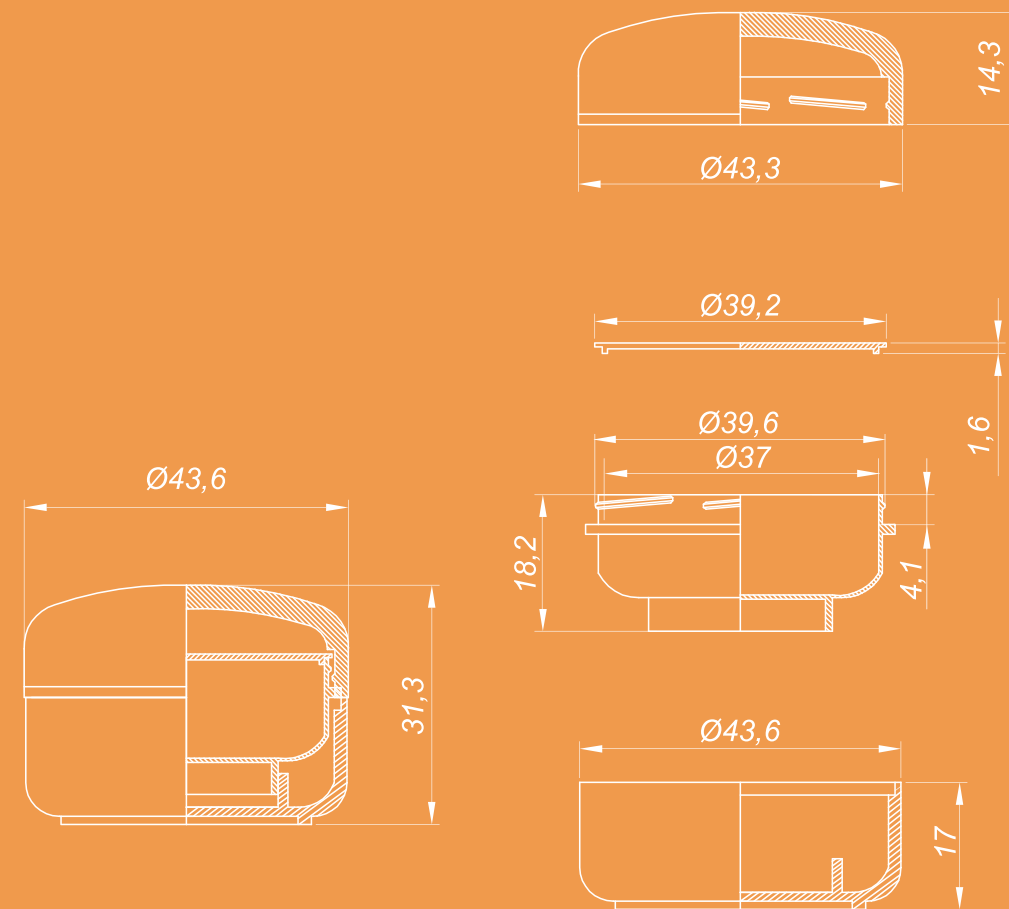

Za pakovanje polučvrstih kozmetičkih proizvoda, krema za lice i slično. Sastoje se od spoljašnjeg i unutrašnjeg dela.

For packaging semi-solid cosmetic products, face creams, and similar items. The jar consists of two parts - an outer part and an inner part.



13015

ml	H	R	material
15	31.3	43.6	PP



13030

ml	H	R	material
30	43.4	59.1	PP



13060

ml	H	R	material
60	61.7	59.1	PP



23150

ml	H	R	material
150	37	93.5	PP



MENTHA

Plastične kutije | sa sigurnosnim prstenom
Plastic Jars with Tamper Evident Band

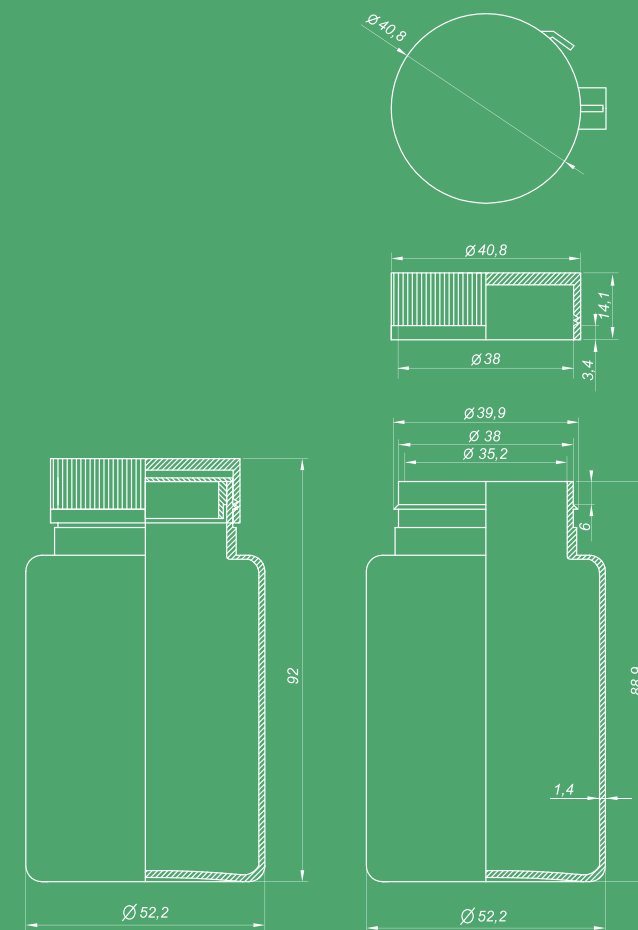

Idealne su za sve vrste tableta i kapsula, i dostupne u 7 različitih zapremina. Poseduju sigurnosni zatvarač koji garantuje evidenciju prvog otvaranja. Jednostavno uklanjanje zaštitnog prstena od LDPE omogućava lako rukovanje.

Ideal for all types of tablets and capsules and are available in 7 different volumes. They feature a safety closure that ensures the record of the first opening. The easy removal of the LDPE tamper-evident ring allows simple handling.

MENTHA

Plastične kutije | sa sigurnosnim prstenom
Plastic Jars with Tamper Evident Band



15020

ml	H	R	material
20	44.6	29.8	PP-LDPE



15050

ml	H	R	material
30	53.5	40.8	PP-LDPE



10600

ml	H	R	material
600	111.2	108	LDPE-HDPE



101000

ml	H	R	material
1000	152.5	108	LDPE-HDPE



15100

ml	H	R	material
100	100	42.3	HDPE-LDPE



15150

ml	H	R	material
150	92	52.2	HDPE-LDPE



101200

ml	H	R	material
1200	173	110.8	LDPE-HDPE

ROSA

Plastične kutije | praškaste
Powder Jars

ROSA

Plastične kutije | praškaste
Powder Jars

Sastoje se od 3 dela: kutije, zatvarača i međupoklopca za doziranje praha. Idealno je za pakovanje svih vrsta prahova, a sigurnosni zatvarač garantuje evidenciju prvog otvaranja. Jednostavno uklanjanje zaštitnog prstena od LDPE omogućava lako rukovanje.

They consist of 3 parts: container, cap, and dosing insert for powders. They are ideal for packaging all types of powders, and the safety closure ensures the record of the first opening. The easy removal of the LDPE tamper-evident ring allows simple handling.



25010

ml	H	R	material
10	51.6	24.6	LDPE



25020

ml	H	R	material
20	61.1	28.5	LDPE



25030

ml	H	R	material
30	70	31	LDPE



25100

ml	H	R	material
100	100	42.3	LDPE-HDPE



25150

ml	H	R	material
150	91.5	52.3	LDPE-HDPE

HEDERA

Staklene kutije
Glass Jars

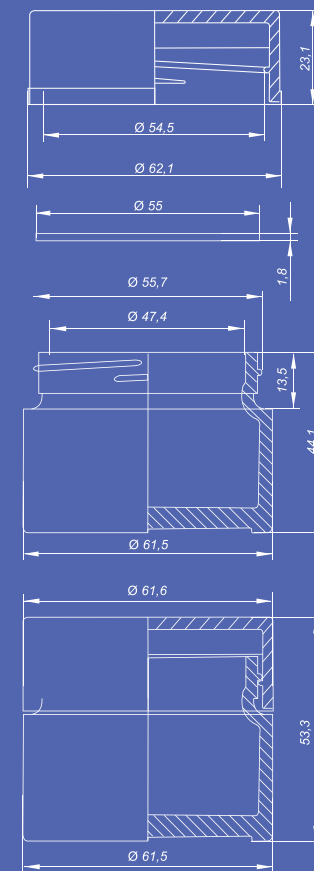

Ova ekskluzivna linija staklene ambalaže, idealna za pakovanje proizvoda za lice, dostupna je u dve zapremine. Zahvaljujući raznim bojama poklopaca i ukrasima, proizvodi se mogu prilagoditi kako prirodnim, tako i luksuznim preparatima.

This exclusive line of glass packaging is ideal for face products, available in two sizes. Thanks to various lid colors and embellishments, the products can be customized for both natural and luxury creams.



60015

ml	H	R	material
15	32.6	40.4	GLASS



60050

ml	H	R	material
50	53.3	61.5	GLASS

Natural / Black / Black + Silver /
Black + Gold / Wood + Silver / Wood + Gold



60051

ml	H	R	material
50	48.6	61.5	GLASS

Sa nižim poklopcem



60050

ml	H	R	material
50	53.3	61.5	GLASS

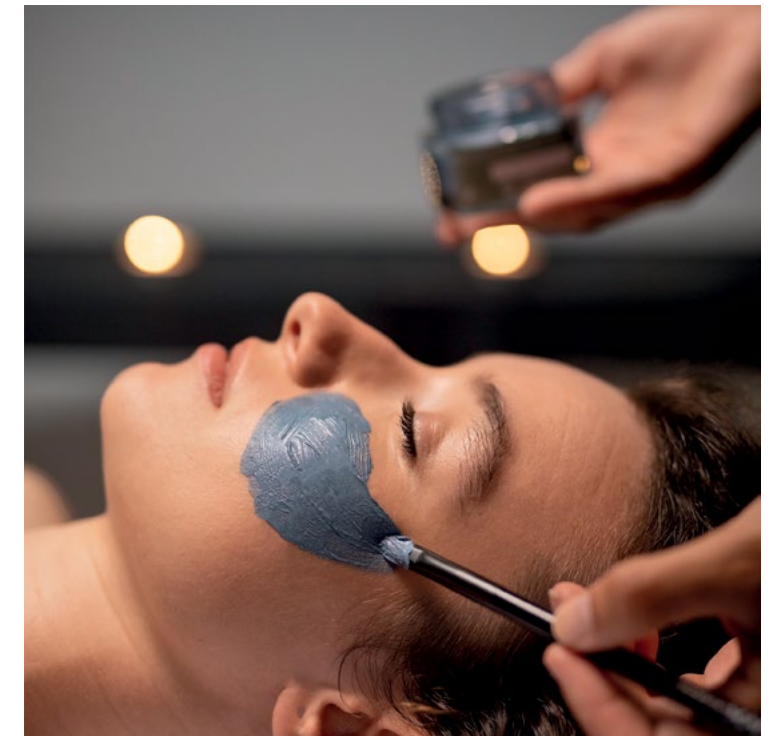

SOL

Aluminijumske kutije
Aluminium Jars

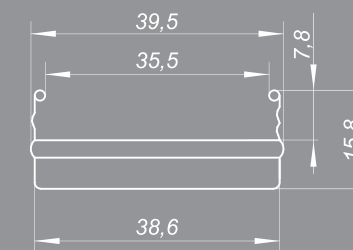
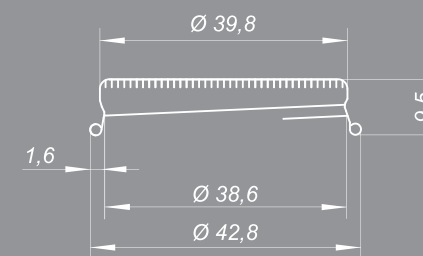
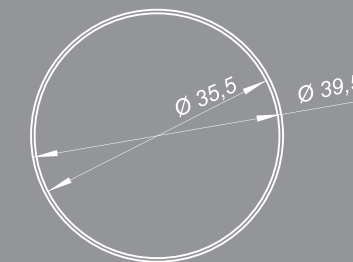
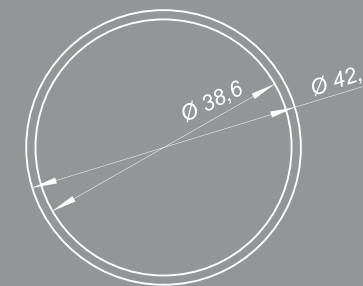
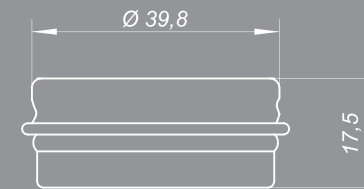

Raspoložive u zapreminama od 10 do 150 ml,
i kao takve veoma svestrane, te se mogu koristiti
za pakovanje proizvoda raznih namena.

Available in volumes from 10 to 150 ml,
can be used for packaging products of various
purposes.

SOL

Aluminijumske kutije Aluminium Jars



61010



ml	H	R	material
10	17.5	42.8	ALU

61030



ml	H	R	material
30	29	43	ALU

61051



ml	H	R	material
50	22.2	61.4	ALU

61050



ml	H	R	material
60	25.7	71.4	ALU

61100



ml	H	R	material
100	27.8	86	ALU

61150



ml	H	R	material
150	38.8	85.9	ALU



PET

TERRA

PET boce PET Bottles



38075P

ml	H	R	material
75	76.5	45.9	PET



38075PC

ml	H	R	material
75	80	45.9	PET



38100P

ml	H	R	material
100	88	46.7	PET
150	106.7	52	PET



38100PC

ml	H	R	material
100	92	85.9	PET
150	110.5	52	PET



**STIKOVII
INHALATORI**
LIPSTICKS & INHALERS

AROMA

Stikovi i inhalatori Lipsticks and Inhalers

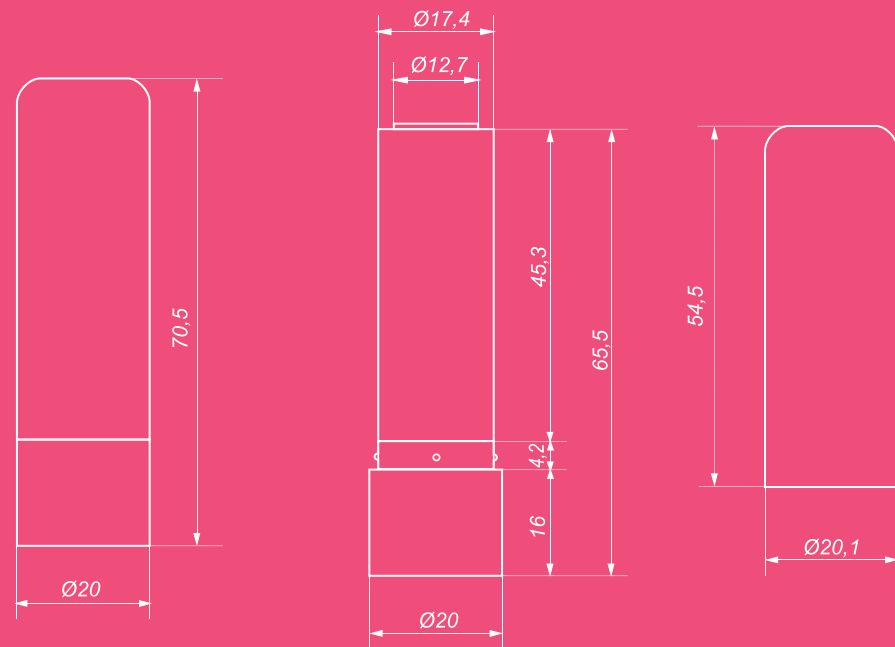

Plastični kontejneri za stikove i inhalatore su namenjeni za pakovanje preparata za opštu namenu - balzami za usne. Boja ambalaže i dodatna štampa mogu biti po zahtevu kupca.

Plastic containers for lipsticks and inhalers are designed for packaging general-purpose products, such as lip balms. The color of the packaging and additional printing can be customized according to the customer's request.

AROMA

Stikovi i inhalatori Lipsticks and Inhalers



14005

ml	H	R	material
4.5 g	70.5	20	PS-PP



17004

ml	H	R	material
-	67	18.1	PP



LIPSTICK

ml	H	R	material
9	43.9	41	PP



KALUP

Spoljne dimenzije: 245 x166 x 50 mm, otvor za stik: 12.7 mm
Outer dimensions: 245 x166 x 50 mm, stick opening: 12.7 mm

MONODOZE

MONODOSE STRIPS



PURA

Monodoze Monodose Strips

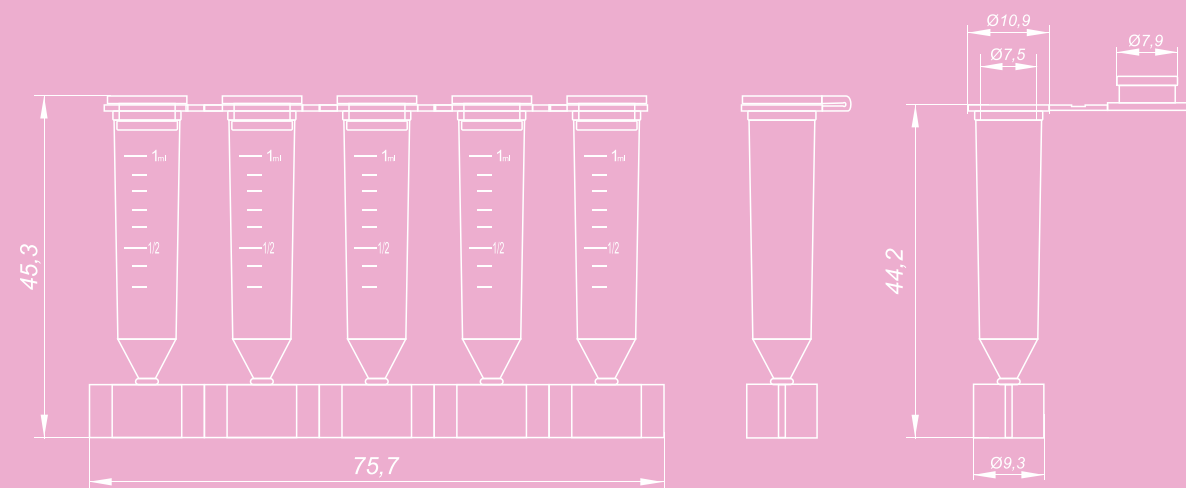

Single dose pakovanje je lako za otvaranje, ali i ponovno zatvaranje. Mogu se spakovati tečni i polučvrsti rastvori pa čak i kreme i gelovi. Isporučuje se u trakama od 5 jedinica, svaka kapaciteta od 1 ml.

Single-dose packaging is easy to open and reclosure. It can be used to store liquid and semi-solid solutions, as well as creams and gels. It comes in strips of 5 pcs, each with a capacity of 1 ml.

PURA

Monodoze
Monodose Strips



MONODOZE

ml	H	R	material
1	45.3	75.7	LDPE





SUPOFORME

SUPPOSITORIES

VIOLETTA

Supoforme
Suppositories

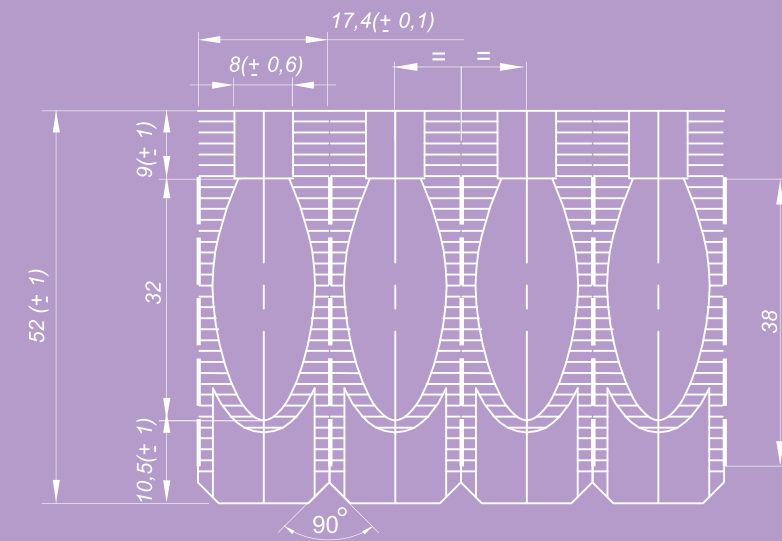

Supoforme se koriste za pakovanje vagitorija i supozitorija (magistralni lek, galenski lek, gotov lek). Dostupne u različitim oblicima i zapreminama.

Suppositories are used for packaging compounded medications, galenic formulations, and ready-made medications. They are available in various shapes and sizes.



16010

ml	H	R	material
2	35.7	65.9	LDPE



16125

ml	H	R	material
2	41.8	72.6	LDPE-PP-PS

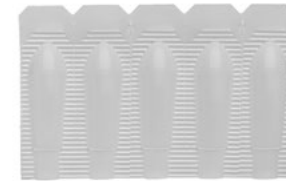

16275

ml	H	R	material
2.75	53.5	12.3	PVC-PE

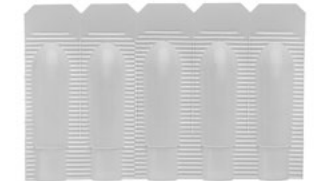

16305

ml	H	R	material
3.05	53	12.6	PVC-PE



16015

ml	H	R	material
1.5	52.8	9.5	PVC-PE

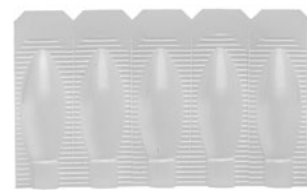

16033

ml	H	R	material
3.3	52	14.8	PVC-PE



16026

ml	H	R	material
2.6	53.5	11.5	PVC-PE

* postoji mogućnost štampanja supoformi /
there is a possibility of printing on sub-forms



Izrađene su od polistirola dok je poklopac izrađen od polietilena čime je obezbeđen kvalitet i bolje dihtovanje. Sterilne posude za uzorkovanje urina i fecesa.

Made of polystyrene (PS), while the cap is made of polyethylene (PE), ensuring quality and better closure. Sterile urine and feces collection containers.



MS 10075 S

ml	H	R	material
75	56.8	53.3	PS-LDP



MS 11015 S

ml	H	R	material
15	47.4	25	PP



URISMART

ml	H	R	material
75	63	53.2	PP-HDP



Nelomljiva sterilna posuda sa seal proof navojnim zatvaračem obezbeđuje maksimalnu zaštitu uzorka.

The sterile container with a seal-proof screw cap provides maximum protection for the sample.

Mašinskim etiketiranjem pružamo brzo i precizno etiketiranje vaših proizvoda, štedeći vam vreme i trud.

With labeling machine, we offer fast and precise labeling of your products, saving you time and effort.



UNIPLAST[®]

Stara pruga 91 | 32212 Preljina
Čačak | Serbia | E763 | Preljina

Prodaja
Sales Department

+381 32 380 285
+381 63 539 995
+381 63 548 884

office@uniplast.rs
prodaja@uniplast.rs

www.uniplast.rs



UNIPLAST[®]
Innovations for Better Tomorrow

loves nature
& cares about it 



UNIPLAST[®]
Innovations for Better Tomorrow.